

DC FUSE

DC 1100V





CERTIFICATE

ATTESTATION CERTIFICATE OF ELECTROMAGNETIC COMPATIBILITY AND LOW VOLTAGE DIRECTIVES

Technical file of the company mentioned below has been observed and audit has been completed successfully.

2014/30/EU Electromagnetic Compatibility Directive and 2014/35/EU Low Voltage Directives have been taken as references for these processes

Company Name : **Suntree Electric Group Co., Ltd.**

Company Address : Xinguang Industrial Zone, Liushi Town, Yueqing City, Zhejiang 325604, P.R.China

Related Directives and Annex : **2014/35/EU Low Voltage Directive**
2014/30/EU Electromagnetic Compatibility Directive

Related Standards : **EN 60947-1:2007+A1:2011+A2:2014; EN 60947-3:2009/A2:2015**
EN 60269-1:2007/A2:2014; EN 60269-6:2011

Product Name : **Fuse Link Fuse Holder**

Report No and Date : **20ZCTS06220045P, 20ZCTS06220035P**

Product Brand/Model/Type : **SRF-30, SRD-30**

Certificate Number : **M.2020.206.C7405**

Initial Assessment Date : **29.06.2020**

Registration Date : **30.06.2020**

Reissue Date/No : **-**

Expiry Date : **29.06.2025**

The validity of the certificate can be checked through www.udem.com.tr. The CE mark shown on the right can only be used under the responsibility of the manufacturer with the completion of EC Declaration of Conformity for all the relevant Directives. This certificate attests the property of UDEM International Certification Auditing Training Centre Industry and Trade Inc. Co. to whom it must be returned upon request. The above named firm must keep a copy of this certificate for 15 years from the registration of certificate. This certificate only covers the product(s) stated above and UDEM must be notified in case of any changes on the product(s).

Address: Mülkiyemahallisi 2073 Sokak (Eski 93 Sokak) No:10 Çankaya - Ankara - TURKEY
 Phone: +90 0312 443 03 90 Fax: +90 0312 443 03 76
 E-mail: info@udemtd.com.tr www.udem.com.tr

 UDEM International Certification
 Auditing Training Centre Industry
 and Trade Inc. Co.
 



CERTIFICATE

of Conformity

Low Voltage Directive 2014/35/EU

Registration No.: **AN 50461255 0001**

Report No.: **50350053 001**

Holder: **Suntree Electric Group Co., Ltd.**
Xinguang Industrial Zone,
Liushi Town, Yueqing City,
Zhejiang 325604
P. R. China

Product: **Fuse Holder**
(Fuse-disconnector)

Identification:

Type Designation	: CH-30, SRD-30
Serial number	: Engineering samples
Utilization Category	: DC-PV0
Rated Operational Voltage (Ue)	: DC 1100V
Rated Operational Current (Ie)	: 1-30A
Conventional Free Air Thermal Current (Ith)	: 30A

This certificate of conformity is based on an evaluation of a sample of the above mentioned product. Technical Report and documentation are at the Licence Holder's disposal. This is to certify that the tested sample is in conformity with Annex I of Council Directive 2014/35/EU, referred to as the Low Voltage Directive. This certificate does not imply assessment of the series-production of the product and does not permit the use of a TÜV Rheinland mark of conformity. The holder of the certificate is authorized to use this certificate in connection with the EC declaration of conformity according to Annex IV of the Directive.

Certification Body

 Zhao Xinhua

Date **16.03.2020**

TÜV Rheinland LGA Products GmbH - Tillystraße 2 - 90431 Nürnberg

CE The CE marking may be used if all relevant and effective EC Directives are complied with. CE



Zertifikat

Certificate

Zertifikat Nr. / Certificate No. **R 50461255** Blatt / Sheet **0001**

Ihr Zeichen / Client Reference **L.M.** Unser Zeichen / Our Reference **01-Wuchale-50350053** Ausstellungsdatum / Date of Issue **001 16.03.2020** (day/month/year)

Genehmigungsinhaber / License Holder **Suntree Electric Group Co., Ltd.** Fertigungsstätte / Manufacturing Plant **Suntree Electric Group Co., Ltd.**
 Xinguang Industrial Zone, Liushi Town, Yueqing City, Zhejiang 325604 P. R. China
 Xinguang Industrial Zone, Liushi Town, Yueqing City, Zhejiang 325604 P. R. China

Prüfzeichen / Test Mark  Geprüft nach / Tested acc. to **EN 60947-3:2009+A1+A2**

Zertifiziertes Produkt (Geräteidentifikation) / Certified Product (Product Identification) **Fuse Holder (Fuse-disconnector)** Lizenzentgelte - Einheit / License Fee - Unit **6**

Type Designation	: CH-30, SRD-30	
Trade mark	: Suntree (logol)	
Utilization Category	: DC-PV0	
Number of Pole	: 1 pole	
Rated Operational Voltage (Ue)	: DC 1100V	
Rated Operational Current (Ie)	: 1-30A	
Rated Insulation Voltage (Ui)	: 1200V	
Rated Impulse Withstand Voltage (Uimp)	: 6kV	
Conventional Free Air Thermal Current (Ith)	: 30A	
Rated Conditional Short-circuit Current	: 30kA	
Pollution Degree	: 3	

ANLAGE (Appendix): 1.0

Dem Zertifikat liegt unsere Prüf- und Zertifizierungsordnung zugrunde und es bestätigt die Konformität des Produktes mit den oben genannten Standards und Prüfverfahren. Zusätzliche Anforderungen an Länder, in denen das Produkt in Verkehr gebracht werden soll, müssen zusätzlich beachtet werden. Die Herstellung des zertifizierten Produktes wird überwacht. This certificate is based on our Testing and Certification Regulation and states the conformity of the product with the standards and testing requirements as indicated above. Any additional requirements in countries where the product is going to be marketed have to be considered additionally. The manufacturing of the certified product is subject to surveillance.

TÜV Rheinland LGA Products GmbH, Tillystraße 2, 90431 Nürnberg
 Tel: +49 221 806-1371 e-mail: cert-validity@de.tuv.com
 Fax: +49 221 806-3935 http://www.tuv.com/safety

Zertifizierungsstelle

 Zhao Xinhua



960°C flame retardant test

The flame can be extinguished by itself within 30 seconds after high-temperature combustion, no molten liquid will drip from the product, and the cotton wool 30 cm below the product will not be ignited. It belongs to the **V0** fire protection class.





Place the product in the test box for 48 hours, set a high temperature of **85°C**, a humidity of 95%, and a low temperature of **-30°C** to simulate whether the extreme environment affects the product.

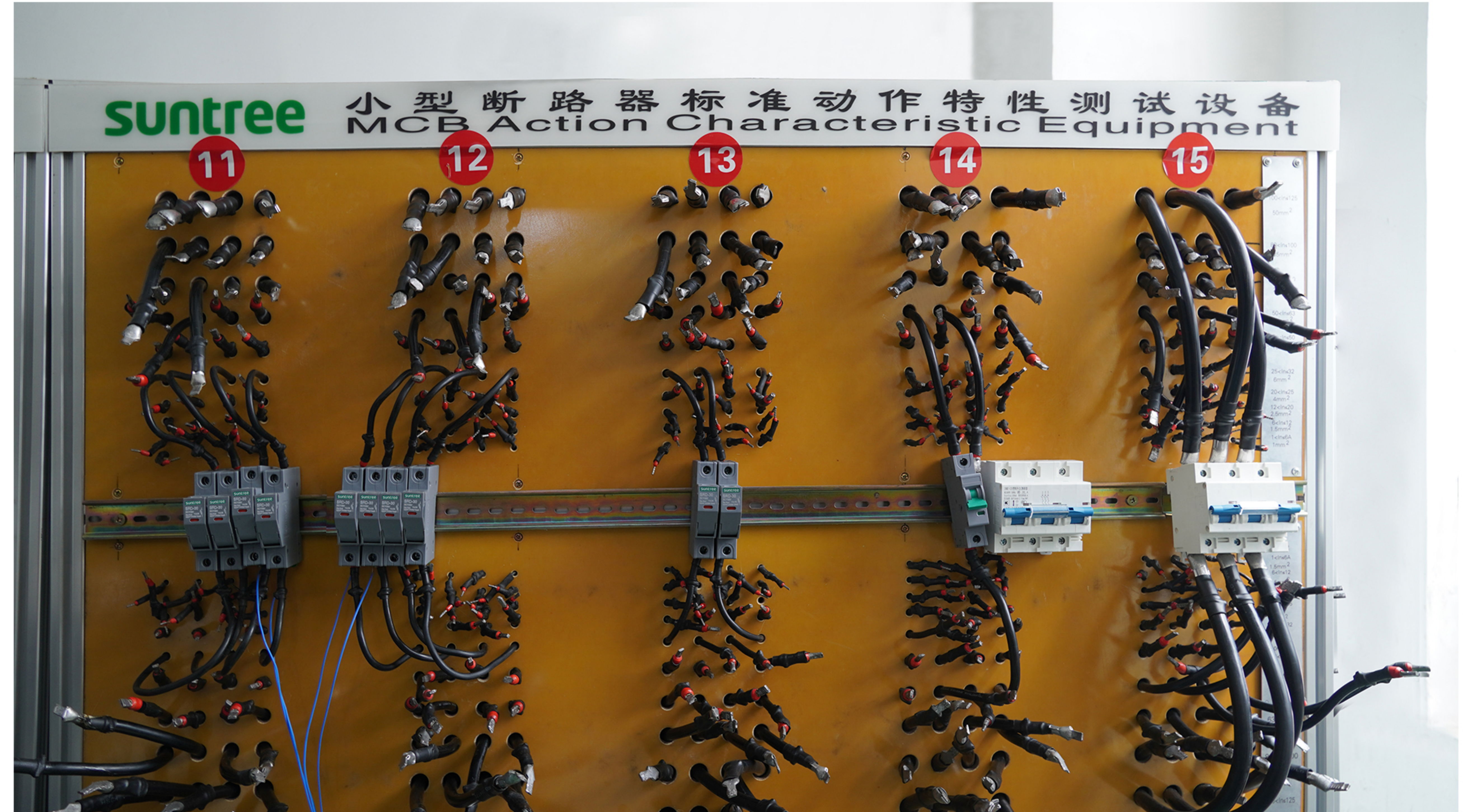

The standard long delay characteristic test mainly tests overload. The switch cannot be turned off within 1 hour, and must be turned off after 1 hour.

The temperature rise test is one of the important tests to ensure the safety and stability of the product. The ambient temperature is required to be between -10 and 40°, and the terminal temperature-ambient temperature is less than 65K.

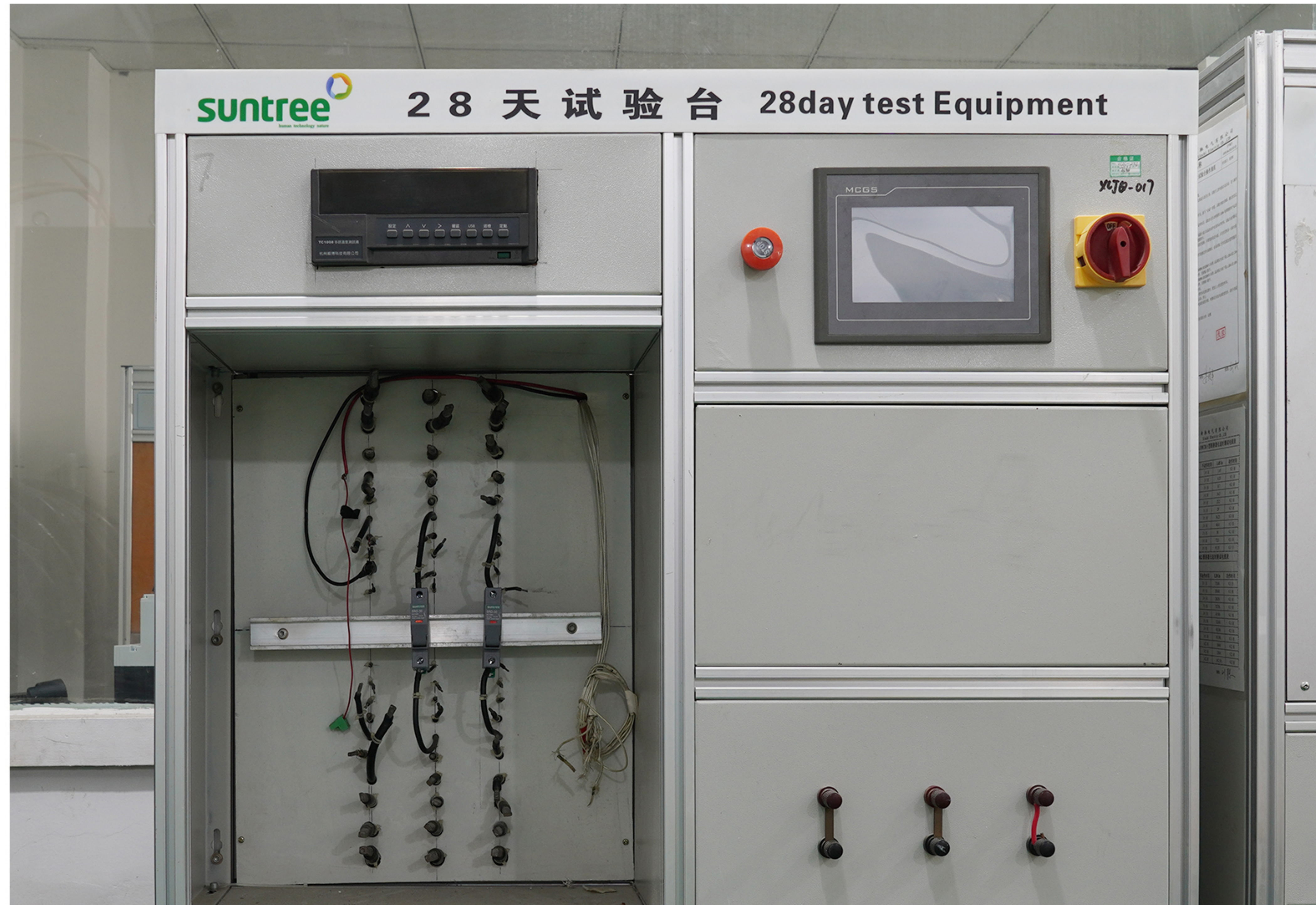

Through 28 days of actual simulation test, verify the reliability of the long-term operation of the fuse.



shockproof

Anti-fall

Prevent product damage in transit.

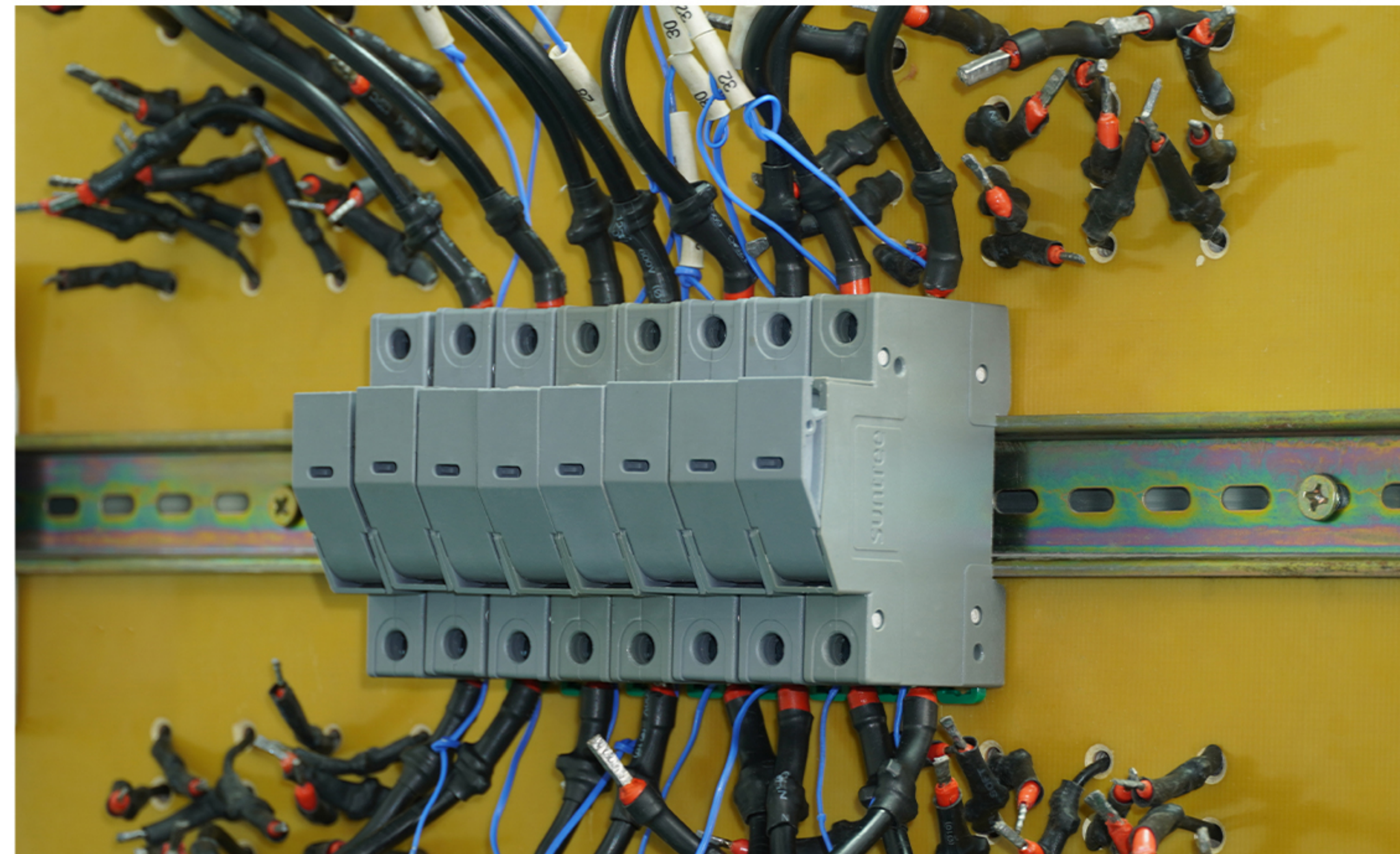
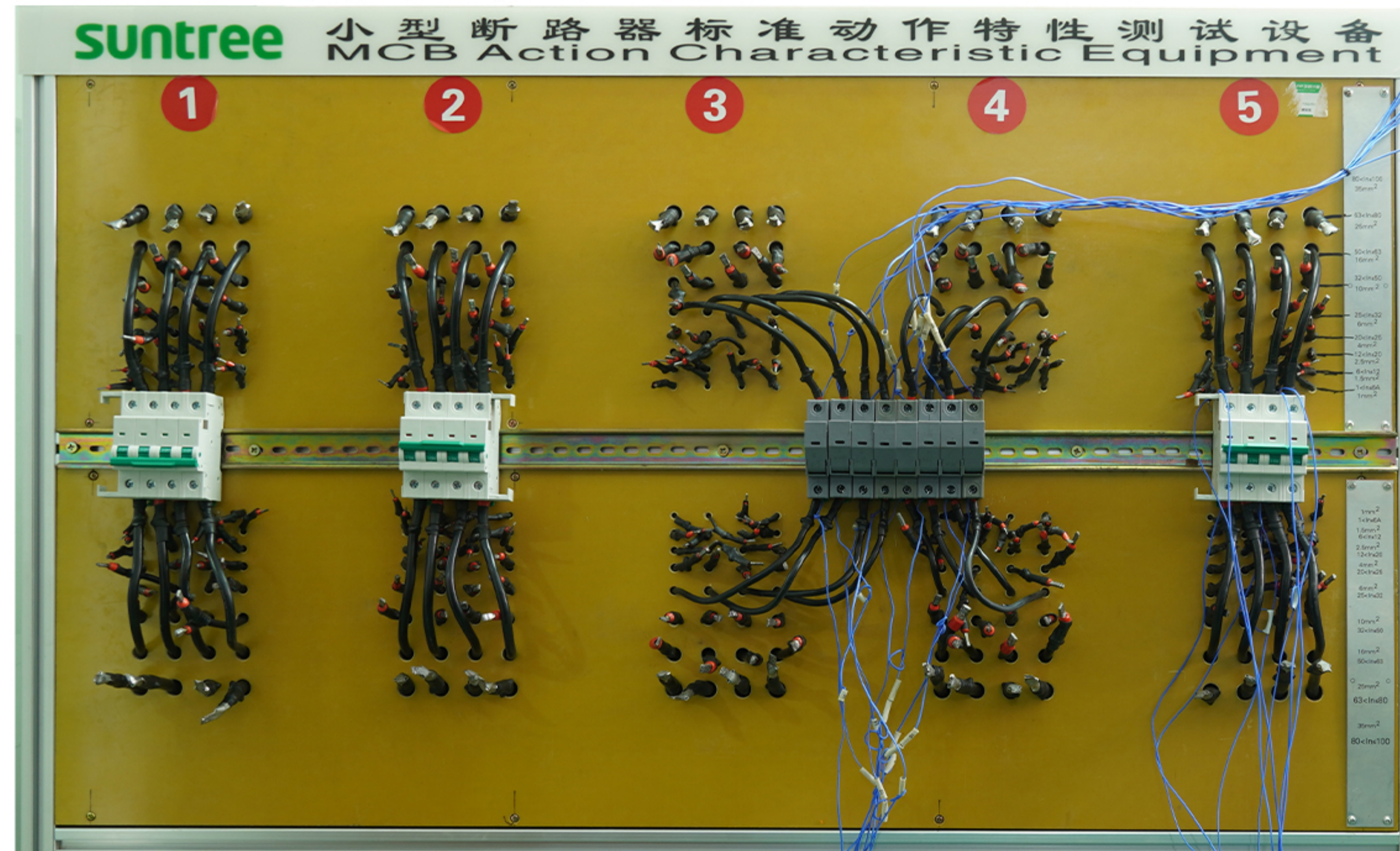

At 25°C, SRD-30 fuse 32A melt core is subjected to 25A temperature rise test, which is one of the important tests to ensure product safety and stability.

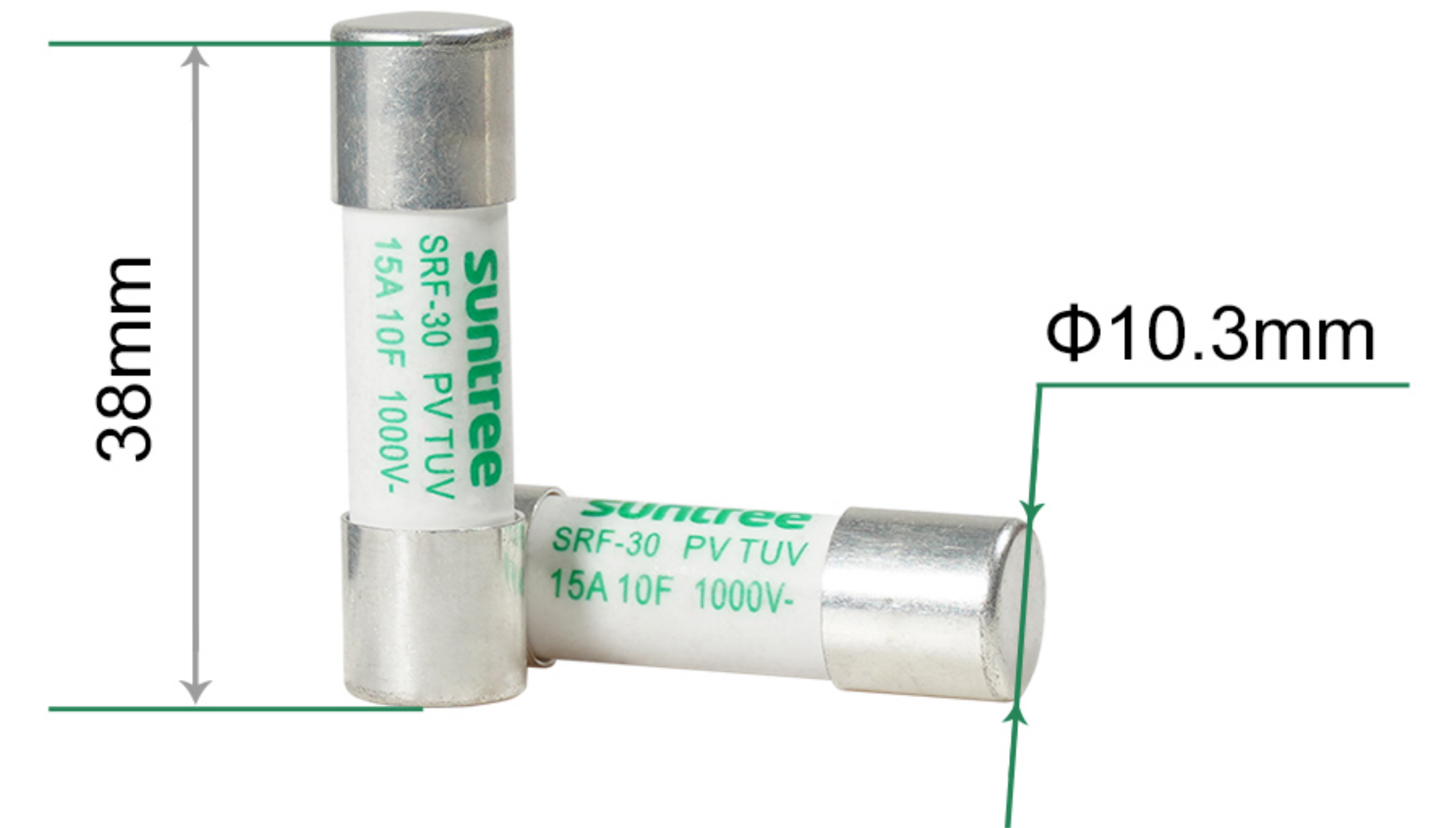
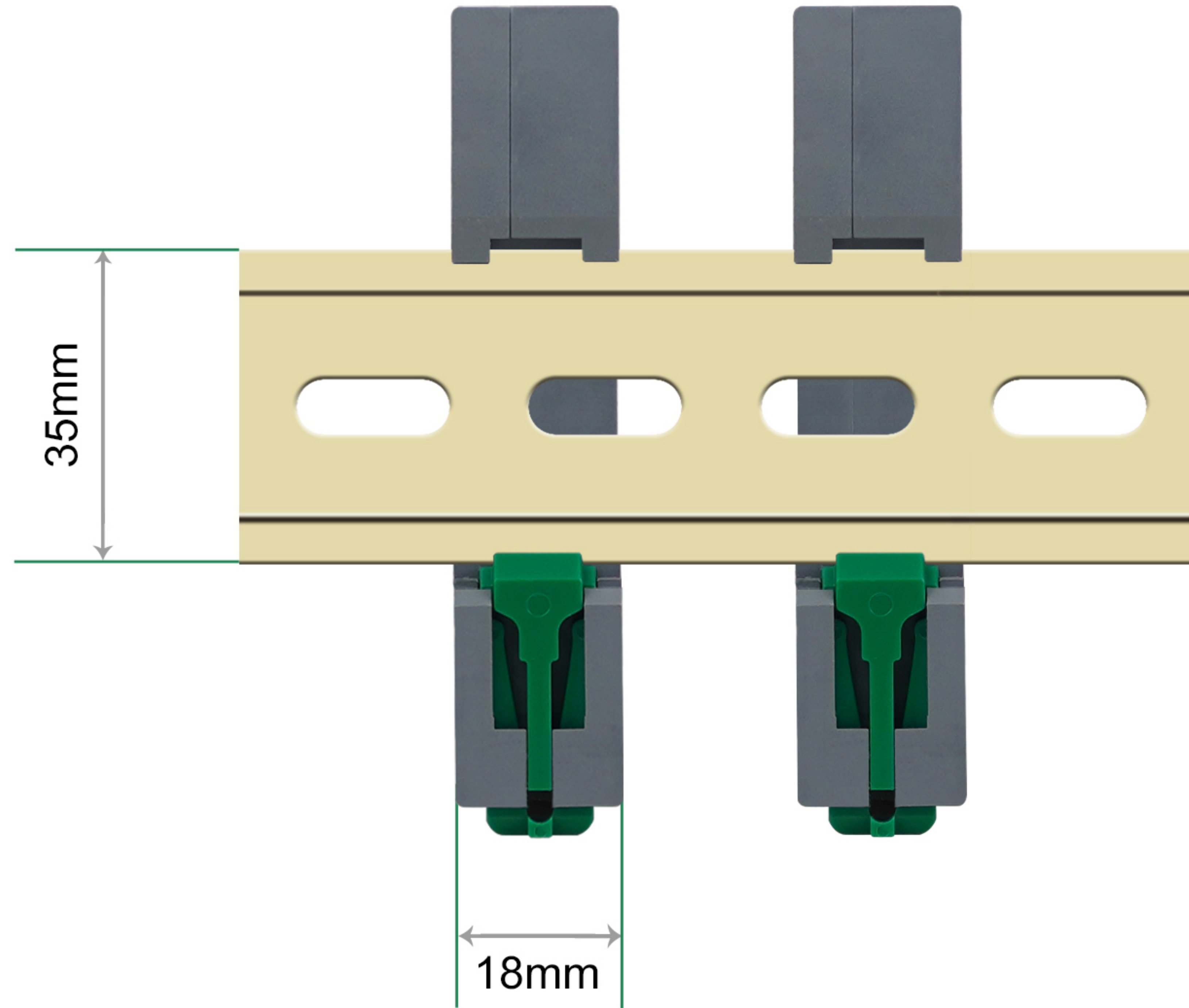
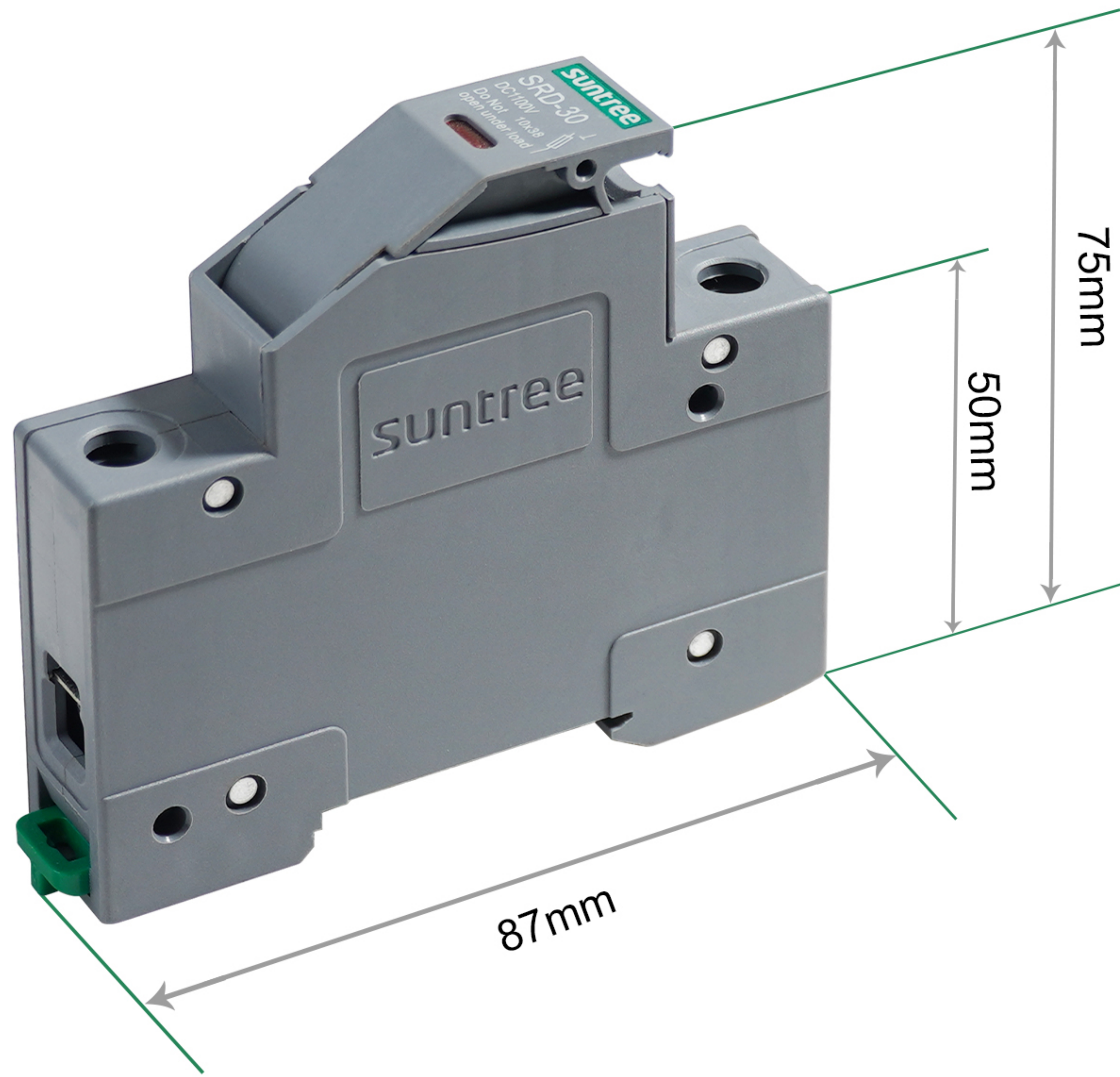

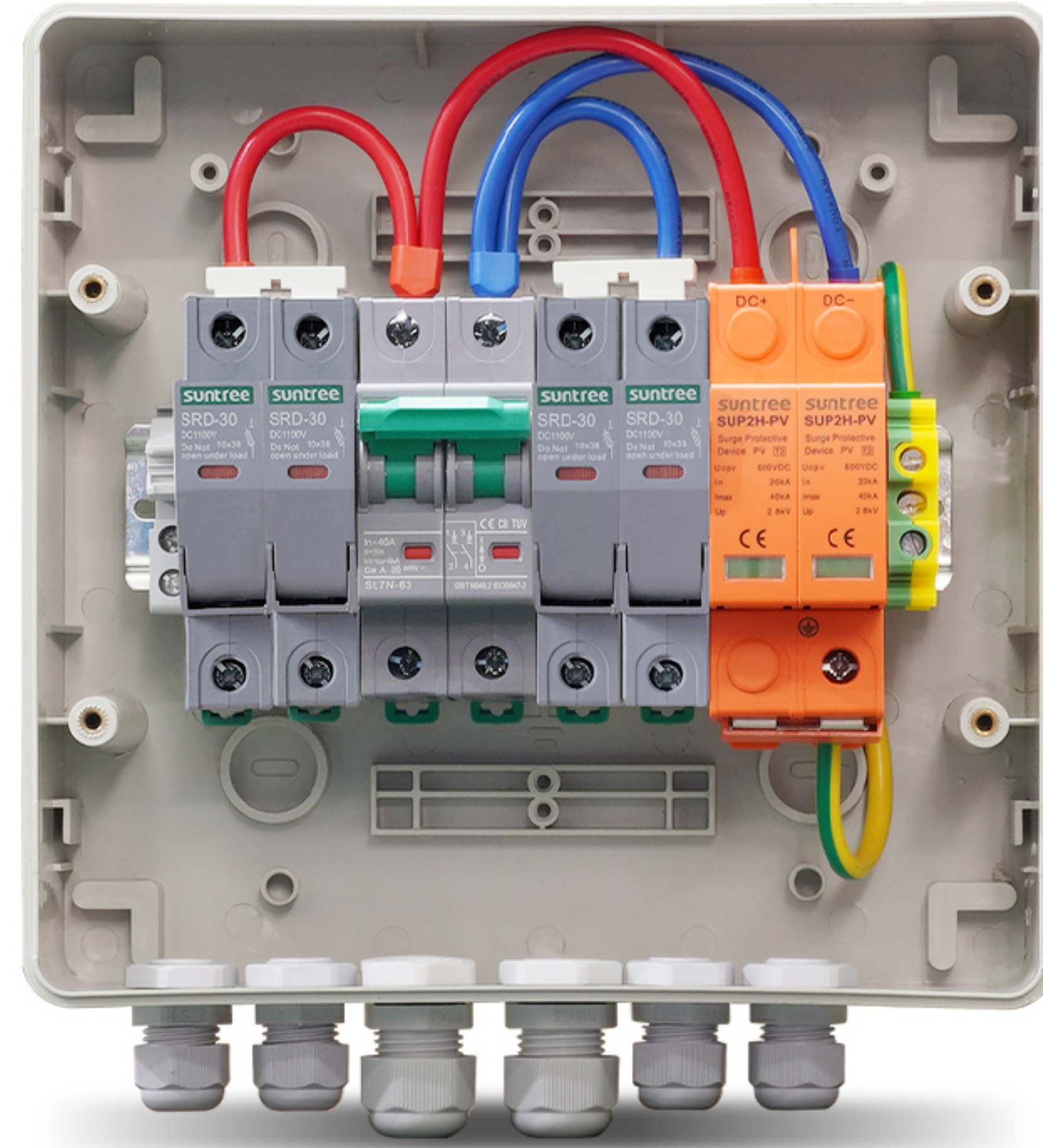

DC COMBINER BOX
TWO IN AND ONE OUT
4*DC FUSE+1*DC MCB+1*DC SPD

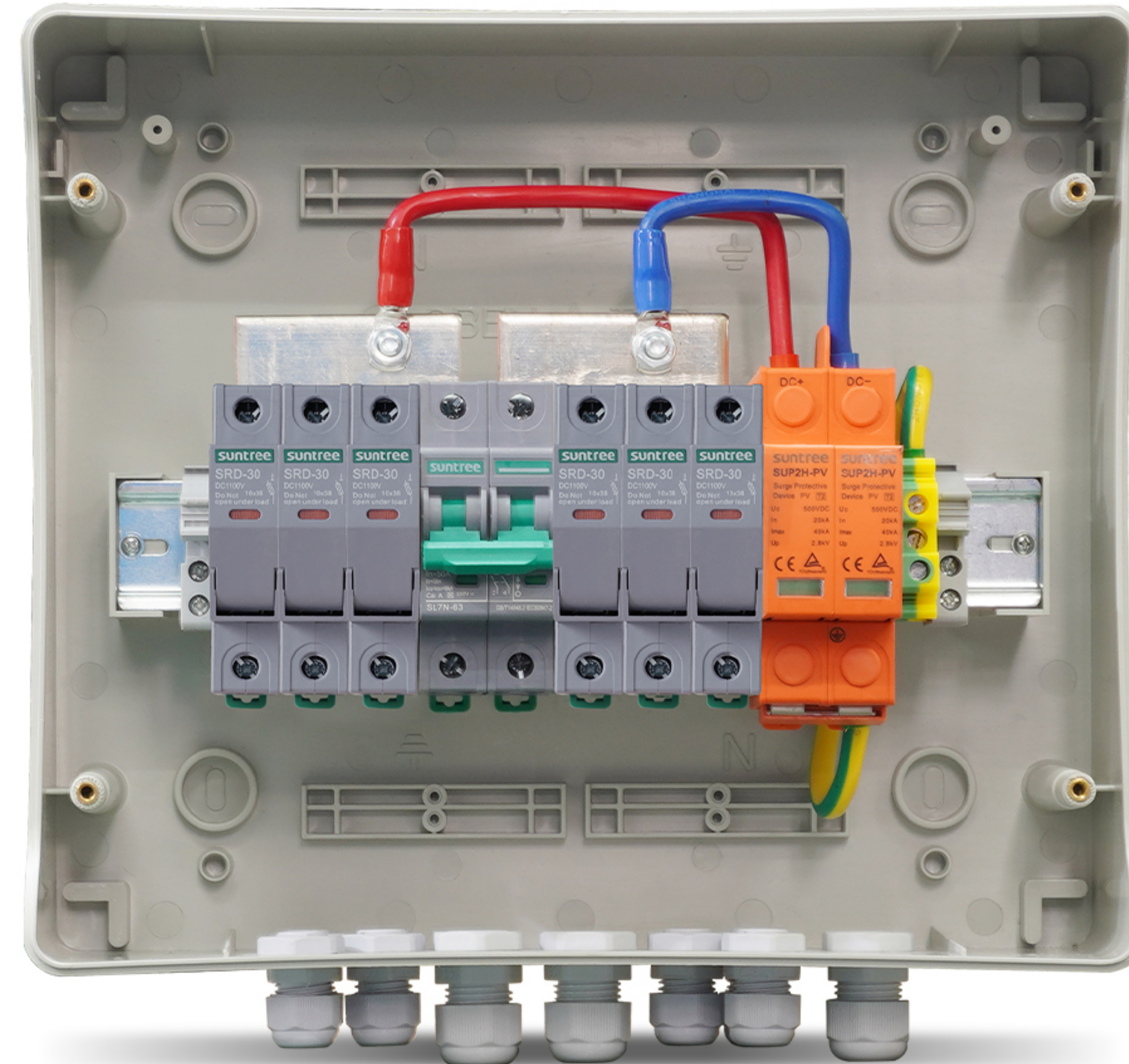

DC COMBINER BOX
THREE IN AND ONE OUT
6*DC FUSE+1*DC MCB+1*DC SPD

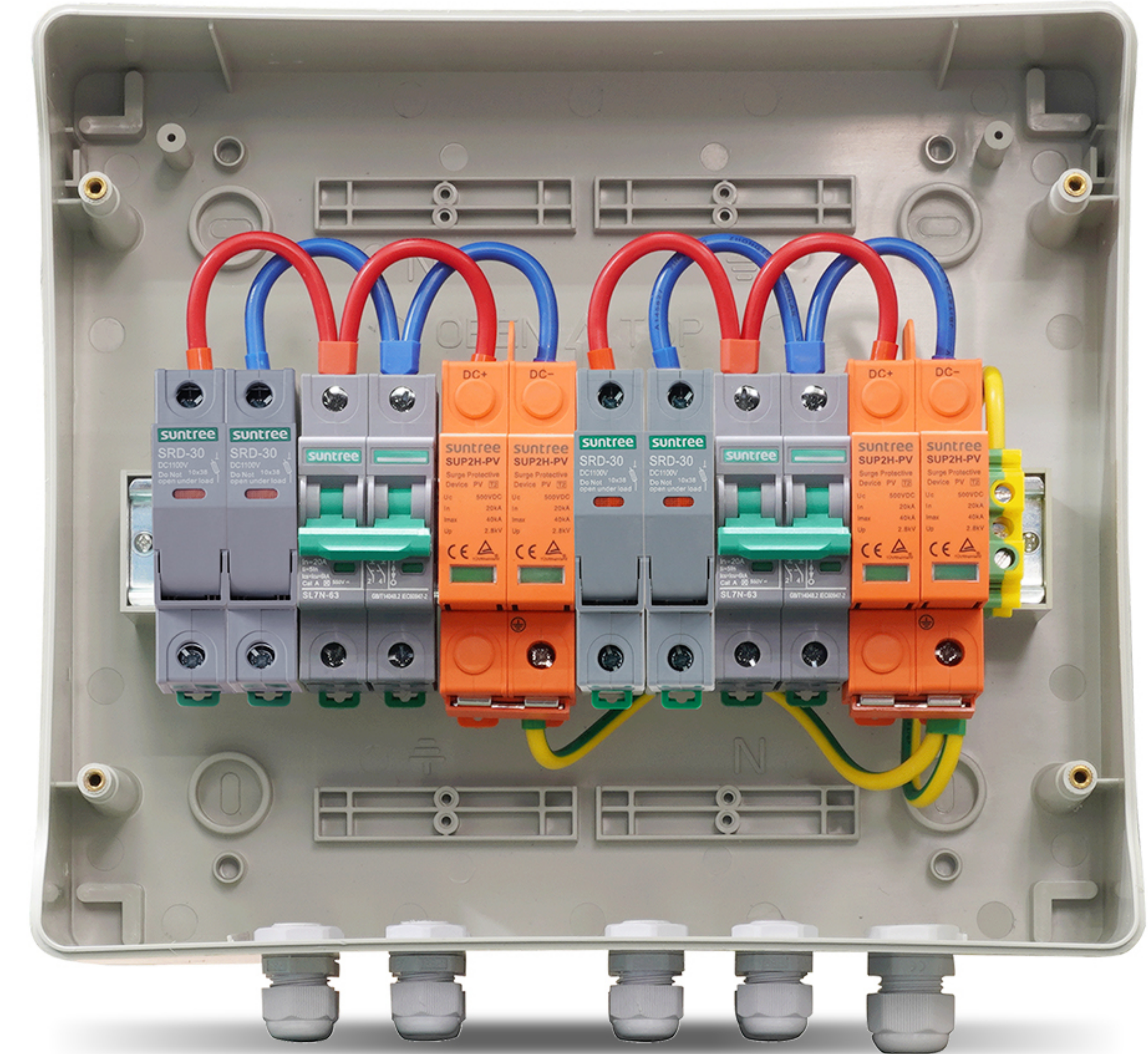

DC COMBINER BOX
TWO IN TWO OUT
4*DC FUSE+2*DC MCB+2*DC SPD

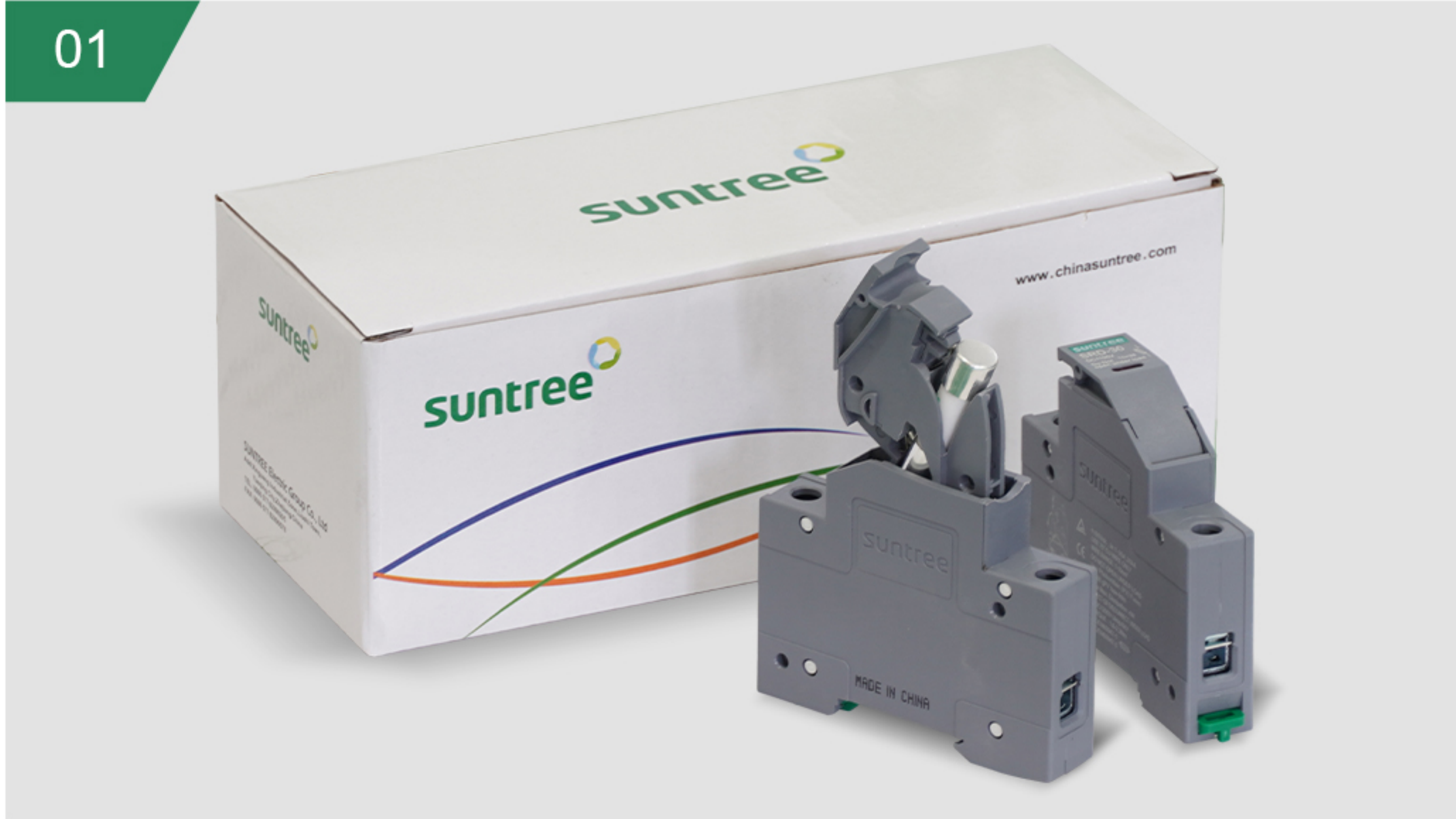

WEIGHT REFERENCE

Product model	SPD-30
N.W./pcs(with fuse)	0.08KG
Weight of fuse	0.01KG
QTY of inner box	12PCS
G.W./box(with fuse)	1.02KG
QTY of outside box	120PCS
weight of one Carton(with fuse)	10.66KG

This parameter is for reference only.



Inner box sticker

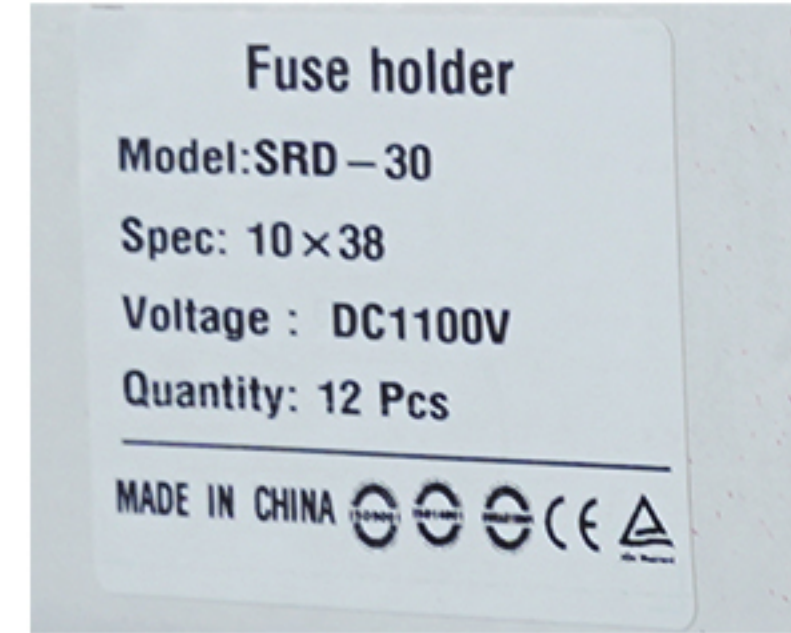

Outer box sticker



When the product is put into storage, the label on the box can conveniently count and identify the quantity, which is convenient to find and improving work efficiency.

suntree
human technology nature

// www.chinasuntree.com